

DHI-ARA24-W2(868)

Wireless keyfob



- SOS emergency alarm.
- Frequency hopping function and two-way communication technology ensure communication stability.
- Cloud update and automatic recovery from update failure.

System Overview

An all new industrial design and advanced technological system, makes the new generation of wireless alarm products easier to install, look better, communicate more reliably and perform more stably. From the comfort of the mobile apps DMSS (for end users) and COS Pro (for installers), receive notifications in real-time, control and manage your devices, perform remote operations, and more.

Scene

Mainly applied for villas, shops, apartments, etc.

Technical Specification

Port

Indicator Light	1 × two-color status indicator (green: normal, red: abnormal)
Button	4 (Home, Away, Disarm, and SOS)

Function

Remote Upgrade	Cloud update
Low Battery Alarm	Yes
Search	Signal strength detection

Wireless

Carrier Frequency	868.0 MHz–868.6 MHz
Communication Distance	Up to 900 m (2,952.76 ft) in an open space
Communication Mechanism	Two-way
Encryption Mode	AES128
Frequency Hopping	Yes

General

Power Supply	CR2032 battery
Power Consumption	Max. 100 mW
Operating Temperature	−10 °C to +55 °C (+14 °F to +131 °F) (indoor)
Operating Humidity	10%–90% (RH)
Product Dimensions	60.0 mm × 39.5 mm × 15.0 mm (2.36" × 1.56" × 0.59") (L × W × H)
Packaging Dimensions	135.0 mm × 98.5 mm × 27.8 mm (5.31" × 3.88" × 1.09") (L × W × H)
Net Weight	20 g (0.04 lb)
Gross Weight	65 g (0.14 lb)
Certifications	CE
Casing	PC + ABS
Battery Life	3 years

Ordering Information

Type	Model	Description
Wireless keyfob	DHI-ARA24-W2(868)	Wireless keyfob

Dimensions (mm[inch])

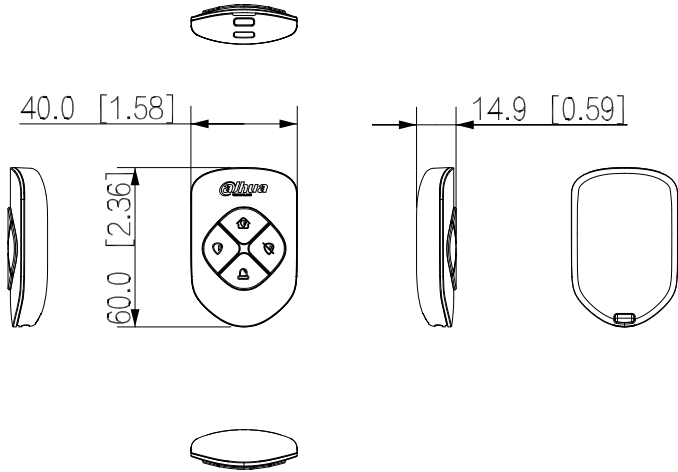

Application

